

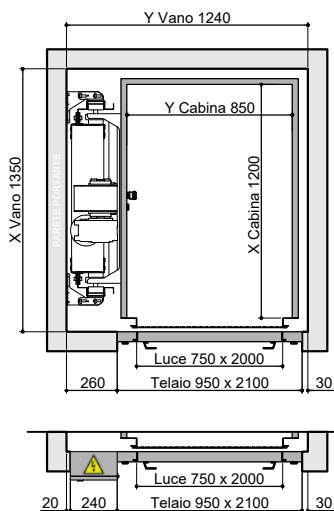

800 X 1200 portata 250 Kg

Accessi Vano in muratura Vano in struttura<sup>1</sup>

**1L**



**Armadio a muro**

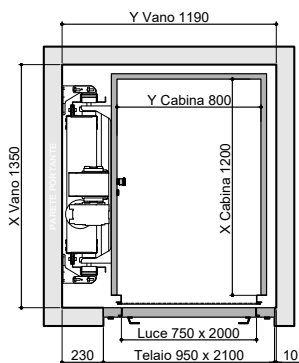

Vano in struttura<sup>1</sup>

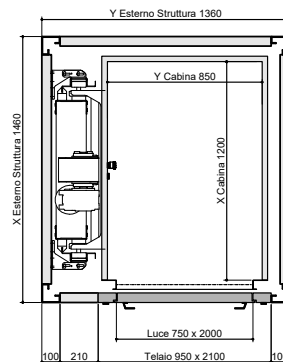

**Armadio a muro**

**1F**

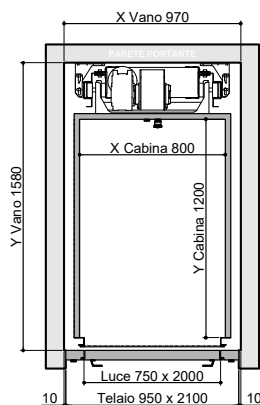

**Armadio a muro**

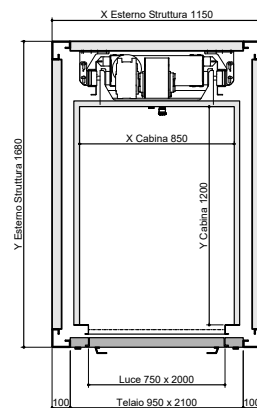

**Armadio a muro**

**20**

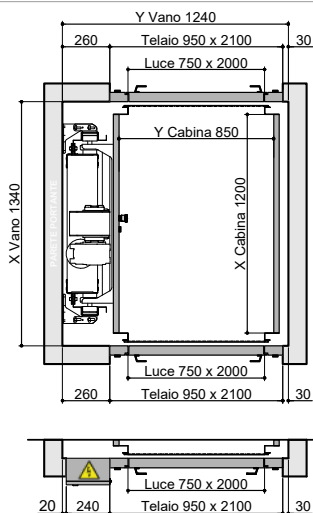

**Armadio a muro**

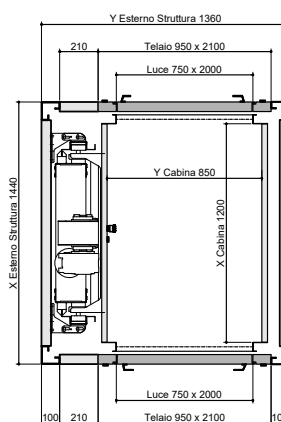
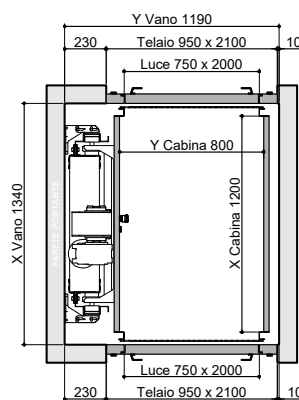

**Armadio a muro**

<sup>1</sup>Gli ingombri potrebbero subire variazioni in funzione delle condizioni di ancoraggio e delle caratteristiche della fornitura (passerelle, parapetti, ecc.). Nel caso siano previste diagonali, considerare un ingombro di 20/30 mm in più sul lato dove saranno installate.



1200 X 1200 portata 400 Kg

Accessi **Vano in muratura** **Vano in struttura<sup>1</sup>**

3

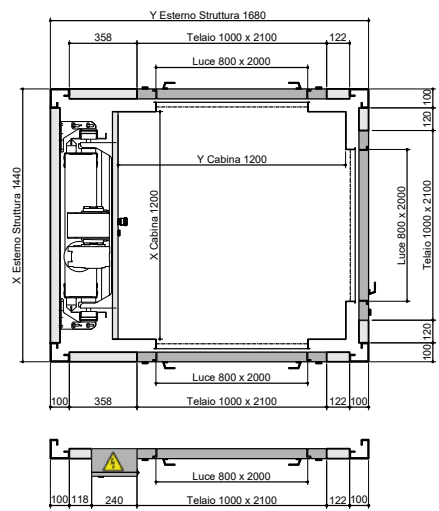
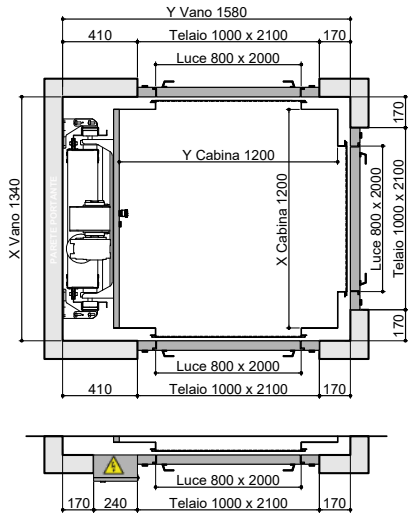

2A

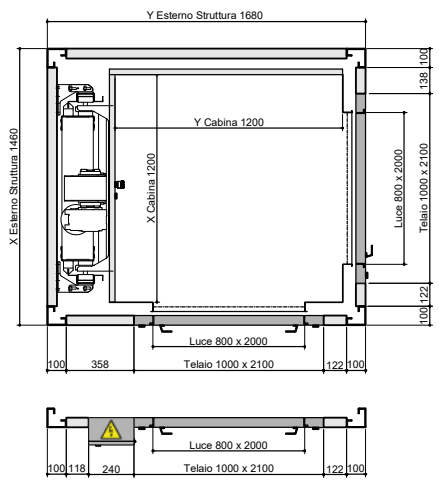
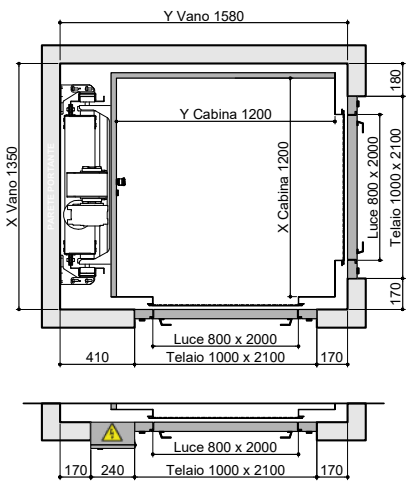

<sup>1</sup>Gli ingombri potrebbero subire variazioni in funzione delle condizioni di ancoraggio e delle caratteristiche della fornitura (passerelle, parapetti, ecc..). Nel caso siano previste diagonali, considerare un ingombro di 20/30 mm in più sul lato dove saranno installate.



950 X 1300 portata 350 Kg



1100 X 1400 portata 400 Kg

## Accessi Vano in muratura

## Vano in struttura<sup>1</sup>

## Vano in muratura

## Vano in struttura<sup>1</sup>

1L

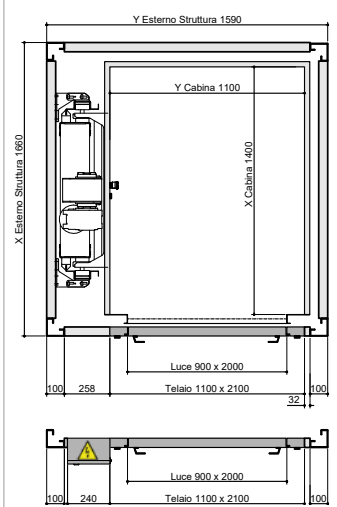
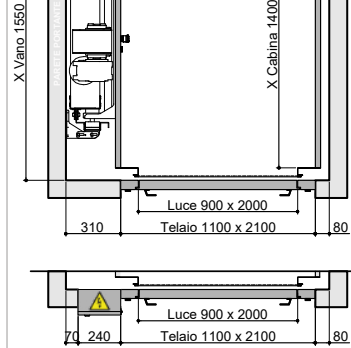
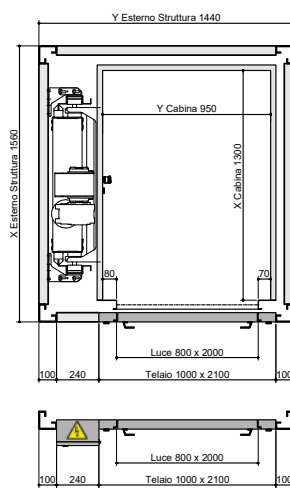
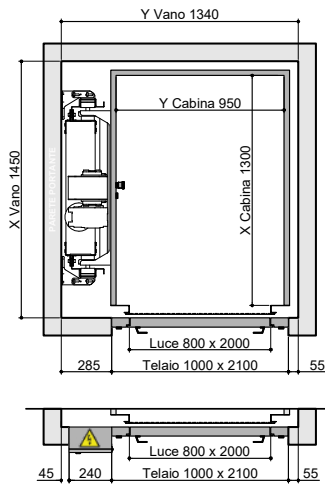

1F

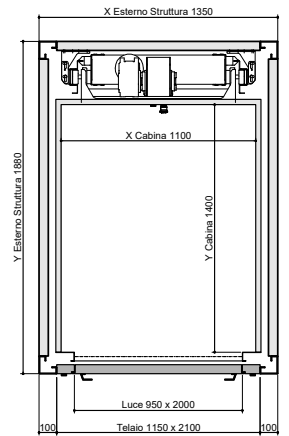
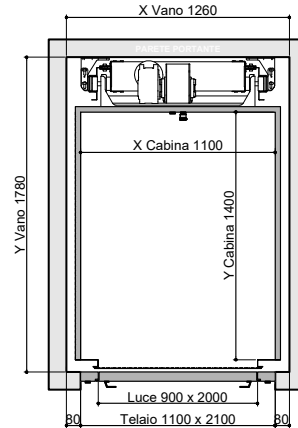
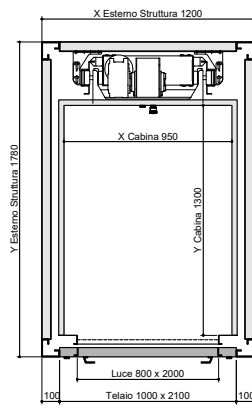
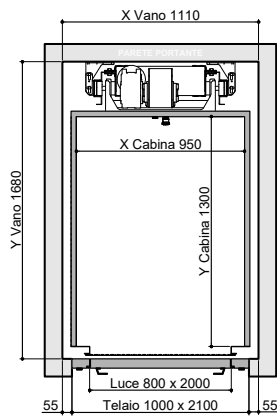

Armadio a muro

Armadio a muro

Armadio a muro

Armadio a muro

20

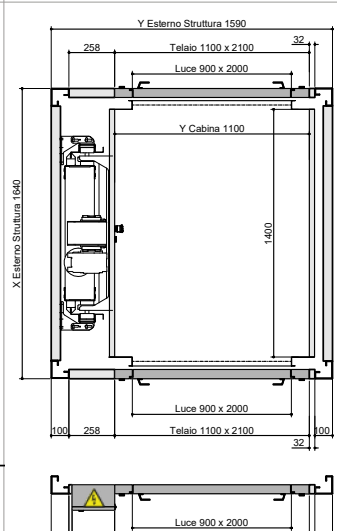
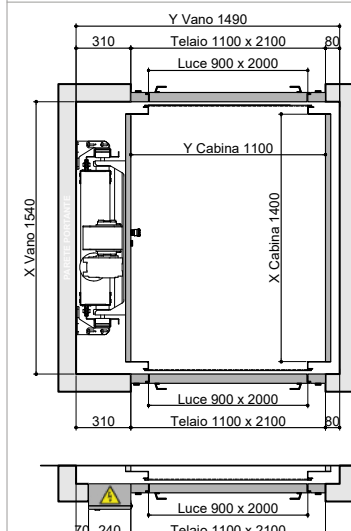
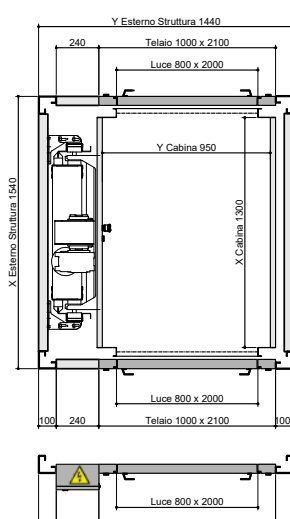
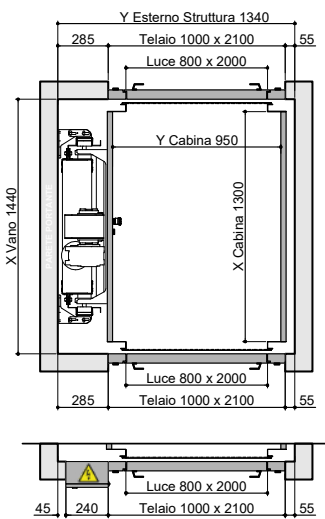

<sup>1</sup>Gli ingombri potrebbero subire variazioni in funzione delle condizioni di ancoraggio e delle caratteristiche della fornitura (passerelle, parapetti, ecc.). Nel caso siano previste diagonali, considerare un ingombro di 20/30 mm in più sul lato dove saranno installate.



1300 X 1300 portata 450 Kg

Accessi **Vano in muratura** **Vano in struttura<sup>1</sup>**

2A

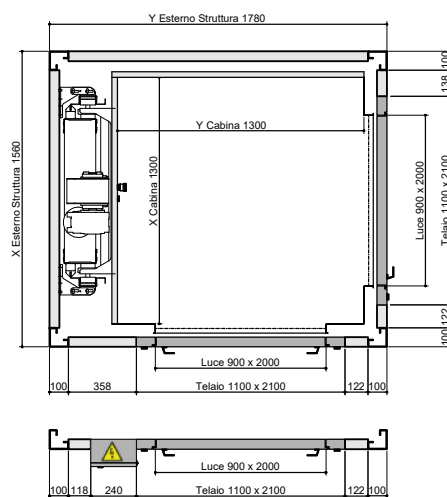
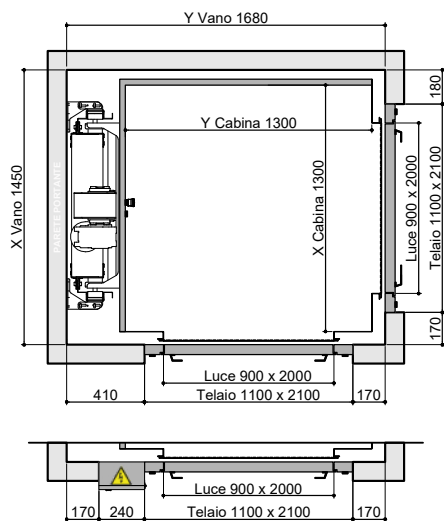

1400 X 1400 portata 500 Kg

Accessi **Vano in muratura** **Vano in struttura<sup>1</sup>**

2A

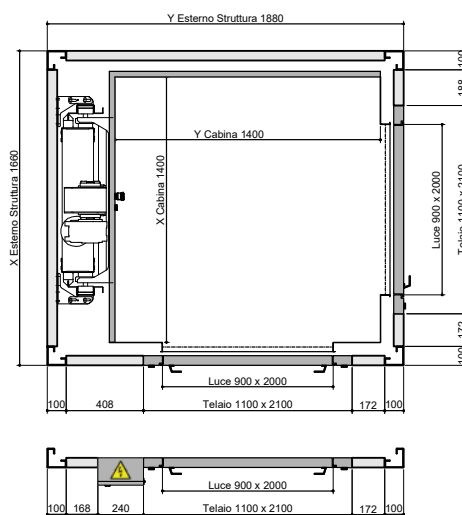
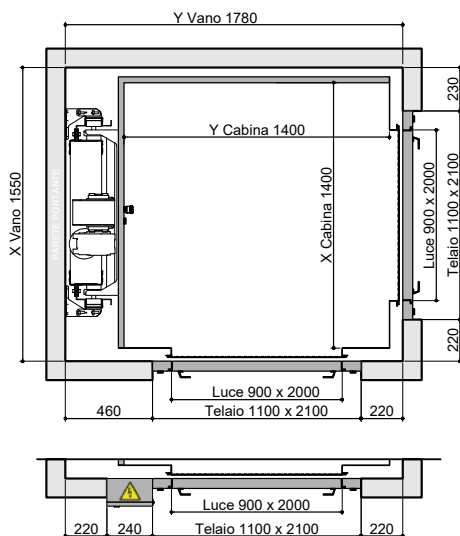

<sup>1</sup>Gli ingombri potrebbero subire variazioni in funzione delle condizioni di ancoraggio e delle caratteristiche della fornitura (passerelle, parapetti, ecc..). Nel caso siano previste diagonali, considerare un ingombro di 20/30 mm in più sul lato dove saranno installate.



## 1000 X 2000 portata 500 Kg

### Accessi

#### Vano in muratura

#### Vano in struttura<sup>1</sup>

1L

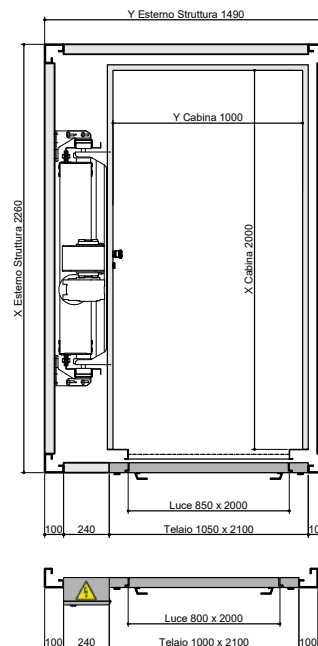
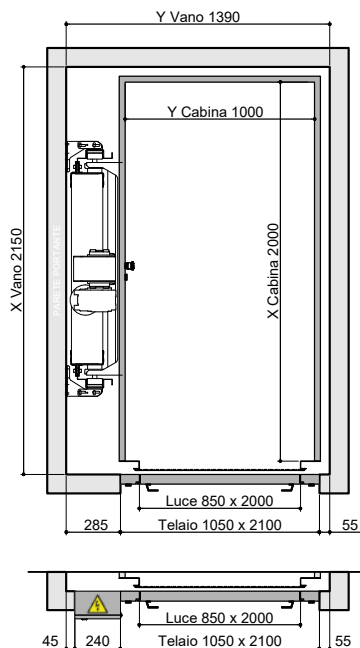

20

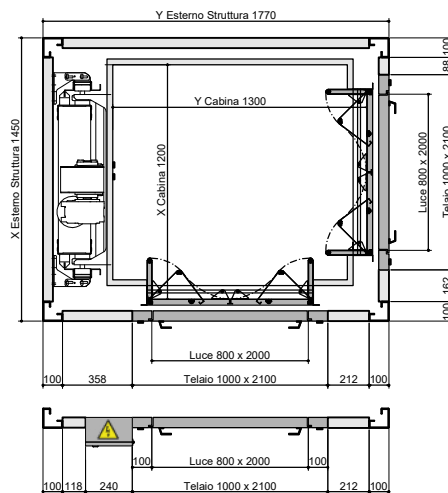
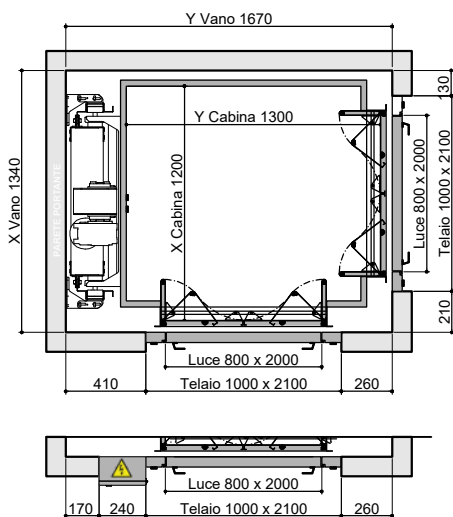

<sup>1</sup>Gli ingombri potrebbero subire variazioni in funzione delle condizioni di ancoraggio e delle caratteristiche della fornitura (passerelle, parapetti, ecc.). Nel caso siano previste diagonali, considerare un ingombro di 20/30 mm in più sul lato dove saranno installate.



800 X 1200 portata 250 Kg

Accessi

Vano in muratura

Vano in struttura<sup>1</sup>

1L

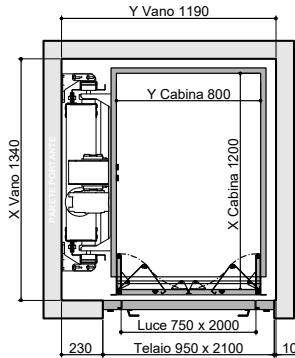
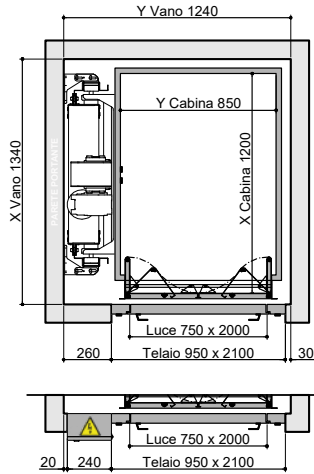

Armadio a muro

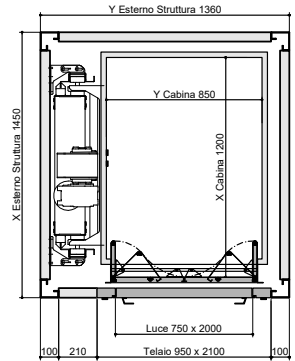

Armadio a muro

1F

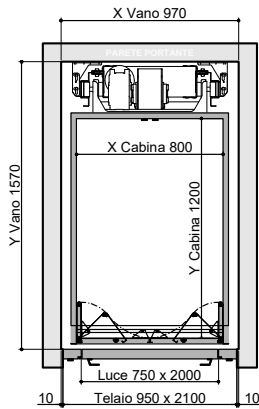

Armadio a muro

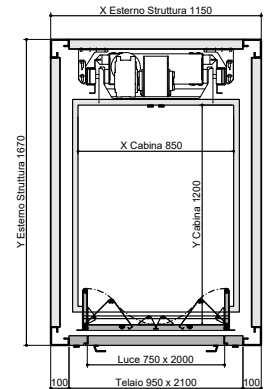

Armadio a muro

20

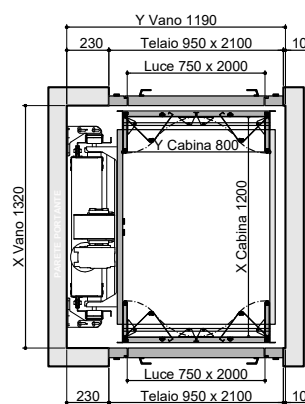
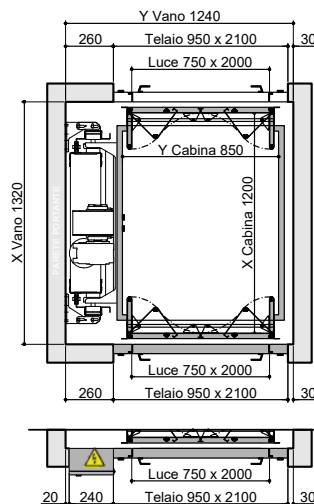

Armadio a muro

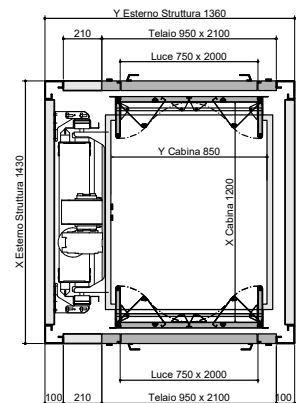

Armadio a muro

<sup>1</sup>Gli ingombri potrebbero subire variazioni in funzione delle condizioni di ancoraggio e delle caratteristiche della fornitura (passerelle, parapetti, ecc..). Nel caso siano previste diagonali, considerare un ingombro di 20/30 mm in più sul lato dove saranno installate.



1200 X 1200 portata 400 Kg

Accessi

Vano in muratura

Vano in struttura<sup>1</sup>

3

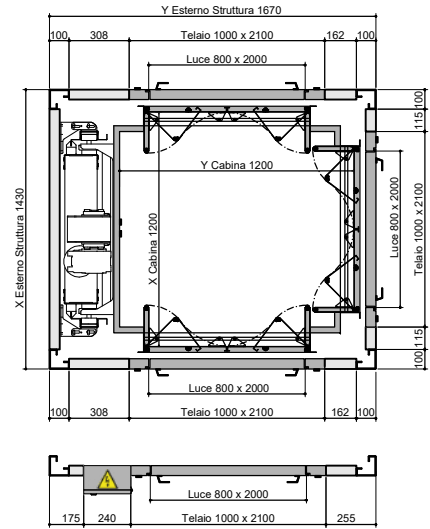
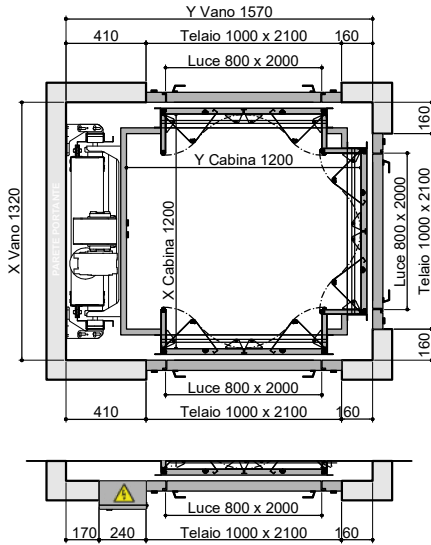

2A

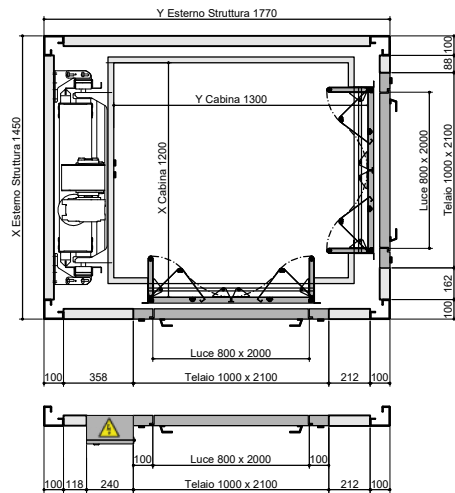
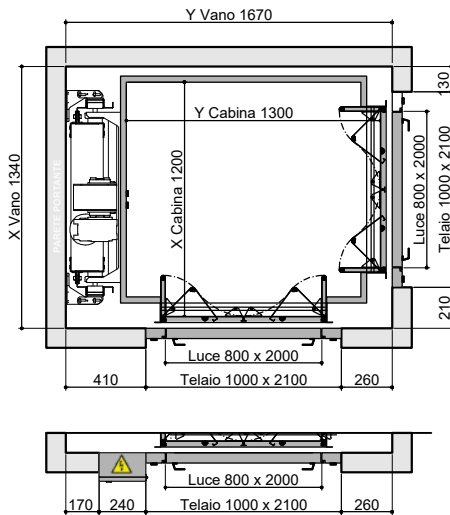

<sup>1</sup>Gli ingombri potrebbero subire variazioni in funzione delle condizioni di ancoraggio e delle caratteristiche della fornitura (passerelle, parapetti, ecc..). Nel caso siano previste diagonali, considerare un ingombro di 20/30 mm in più sul lato dove saranno installate.



950 X 1300 portata 350 Kg



1100 X 1400 portata 400 Kg

Accessi Vano in muratura

Vano in struttura<sup>1</sup>

1L

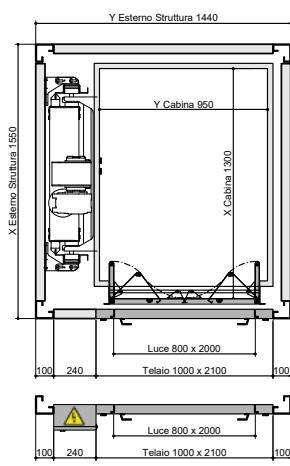
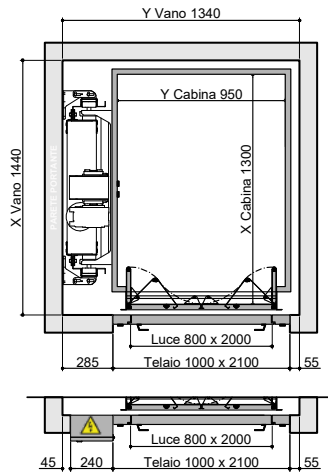

Vano in muratura

Vano in struttura<sup>1</sup>

X Vano 1540

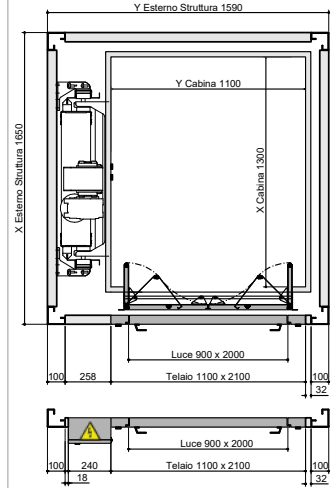
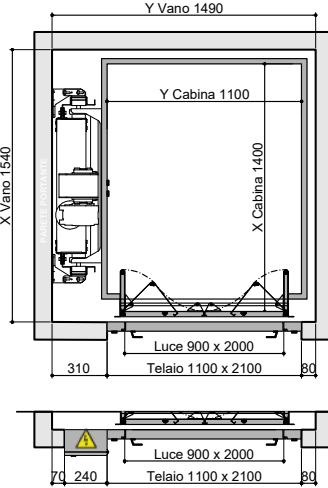

1F

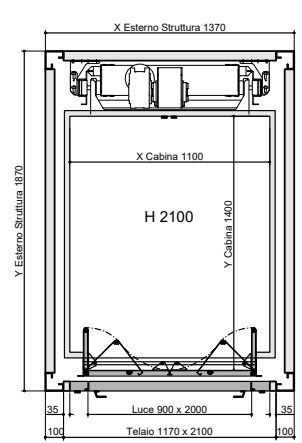
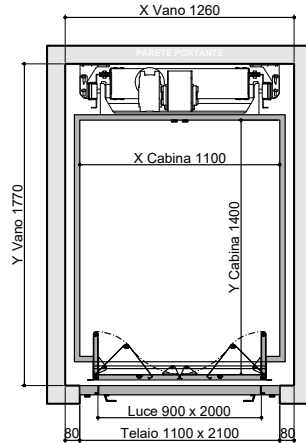
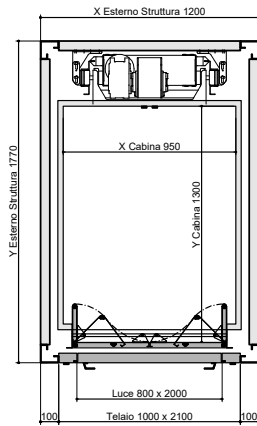
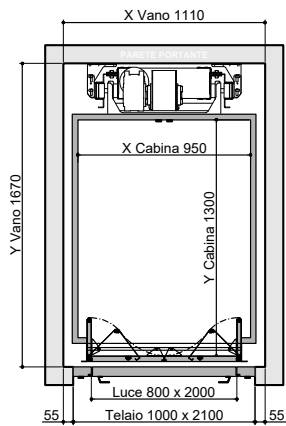

Armadio a muro

Armadio a muro

Armadio a muro

Armadio a muro

20

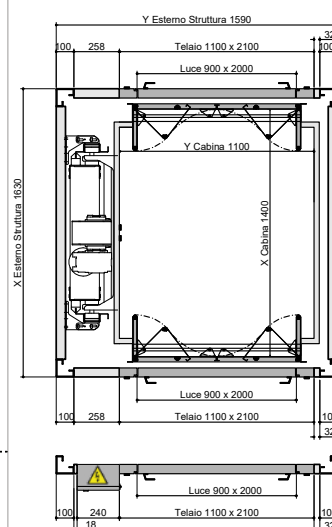
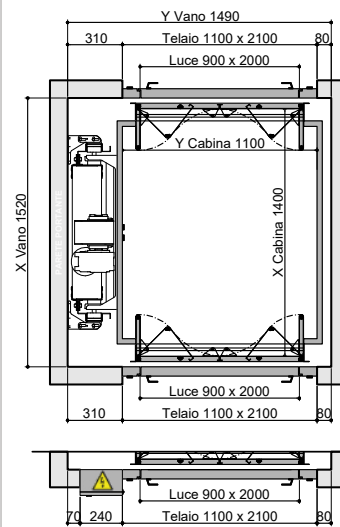
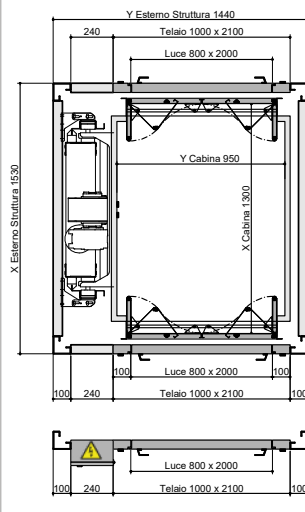
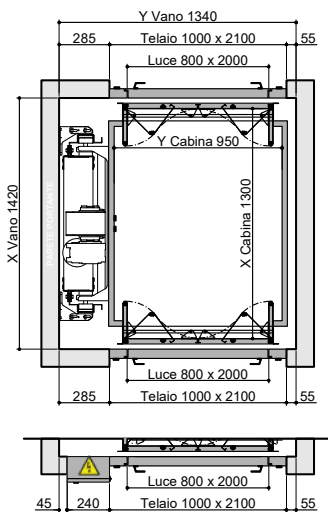

<sup>1</sup>Gli ingombri potrebbero subire variazioni in funzione delle condizioni di ancoraggio e delle caratteristiche della fornitura (passerelle, parapetti, ecc.). Nel caso siano previste diagonali, considerare un ingombro di 20/30 mm in più sul lato dove saranno installate.





1300 X 1300 portata 450 Kg

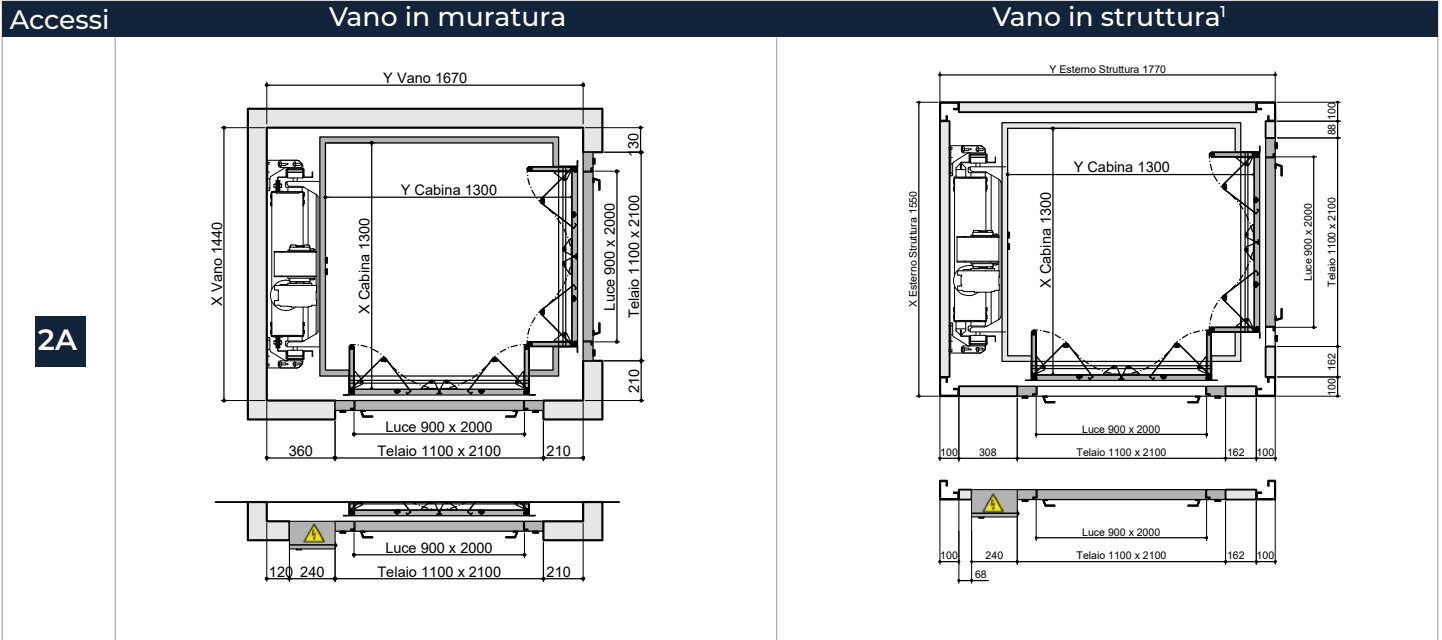

1400 X 1400 portata 500 Kg

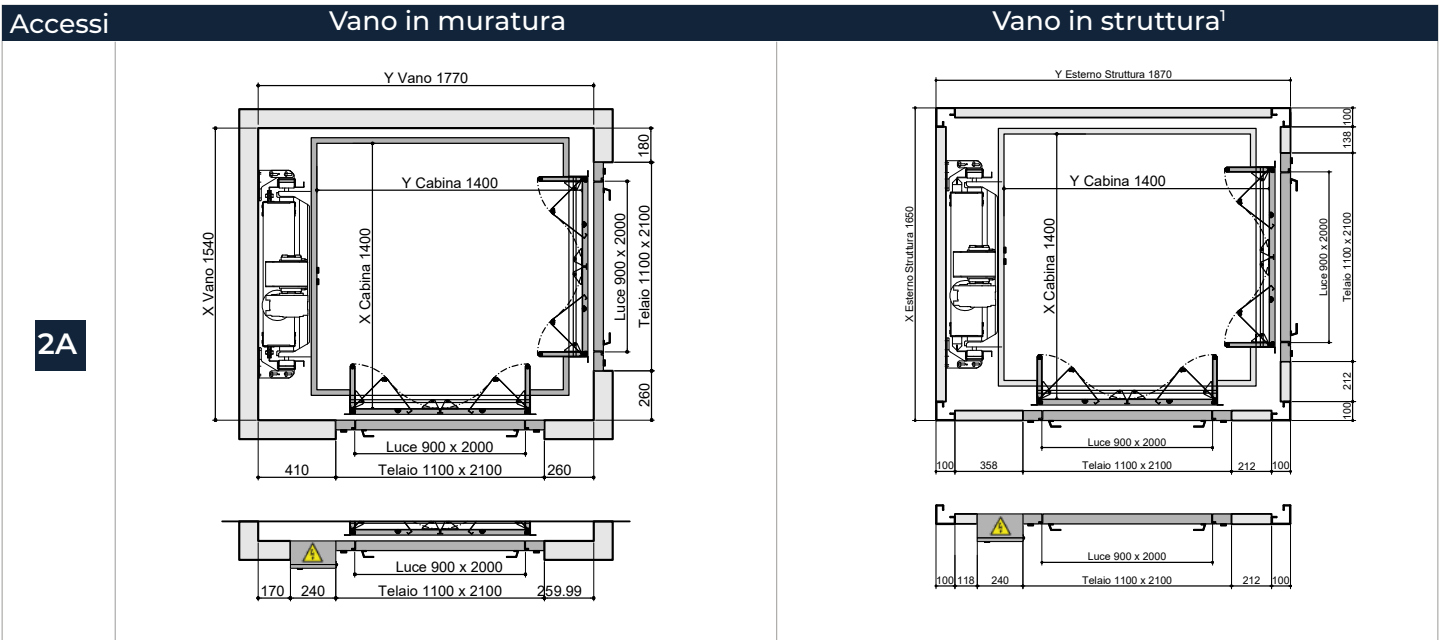

<sup>1</sup>Gli ingombri potrebbero subire variazioni in funzione delle condizioni di ancoraggio e delle caratteristiche della fornitura (passerelle, parapetti, ecc..). Nel caso siano previste diagonali, considerare un ingombro di 20/30 mm in più sul lato dove saranno installate.



1000 X 2000 portata 500 Kg

Accessi

Vano in muratura

Vano in struttura<sup>1</sup>

1L

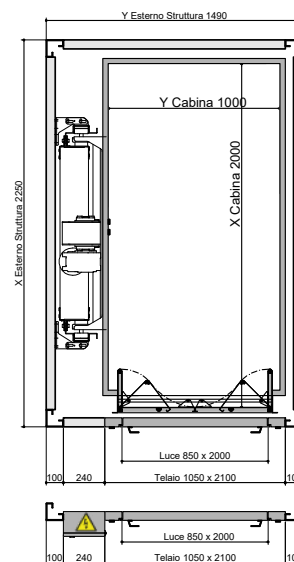
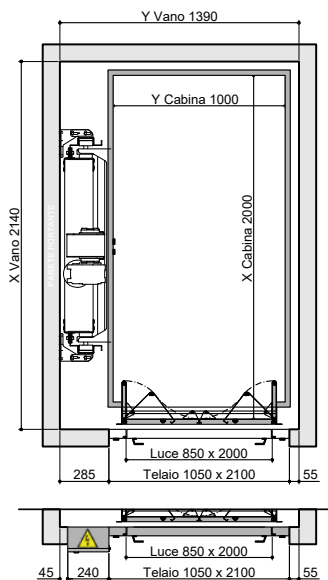

20

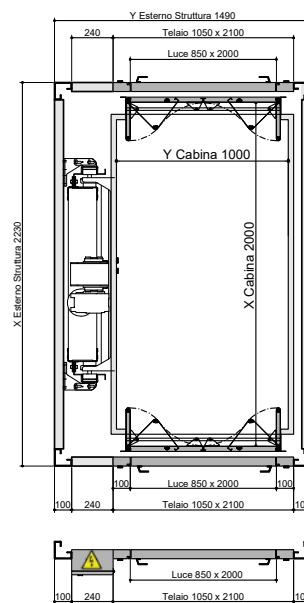
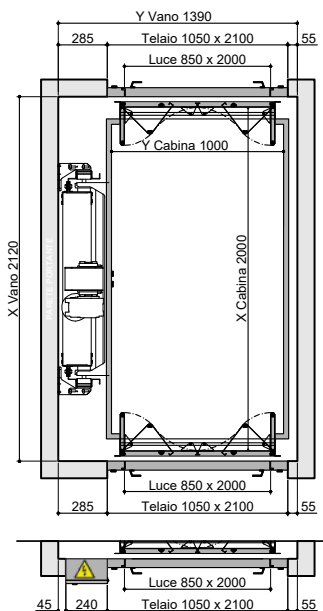

<sup>1</sup>Gli ingombri potrebbero subire variazioni in funzione delle condizioni di ancoraggio e delle caratteristiche della fornitura (passerelle, parapetti, ecc..). Nel caso siano previste diagonali, considerare un ingombro di 20/30 mm in più sul lato dove saranno installate.



800 X 1200 portata 250 Kg

Accessi

Vano in muratura

Vano in struttura<sup>1</sup>

1L

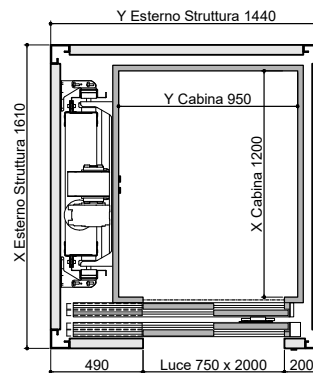
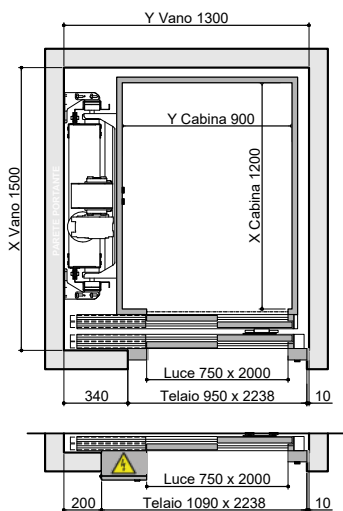

Armadio a muro

1F

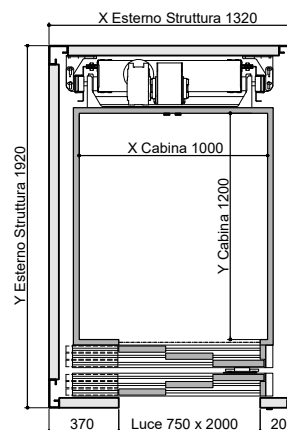
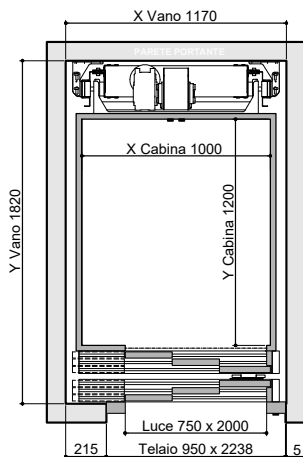

Armadio a muro

20

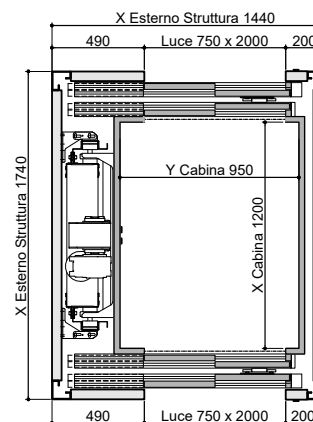
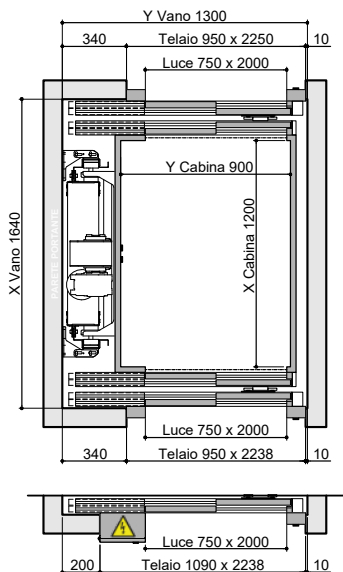

Armadio a muro

<sup>1</sup>Gli ingombri potrebbero subire variazioni in funzione delle condizioni di ancoraggio e delle caratteristiche della fornitura (passerelle, parapetti, ecc..). Nel caso siano previste diagonali, considerare un ingombro di 20/30 mm in più sul lato dove saranno installate.



1200 X 1200 portata 400 Kg

Accessi Vano in muratura Vano in struttura<sup>1</sup>

3

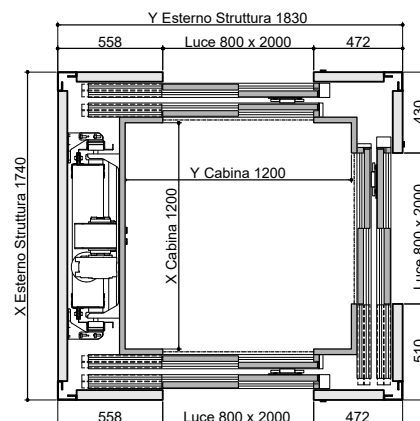
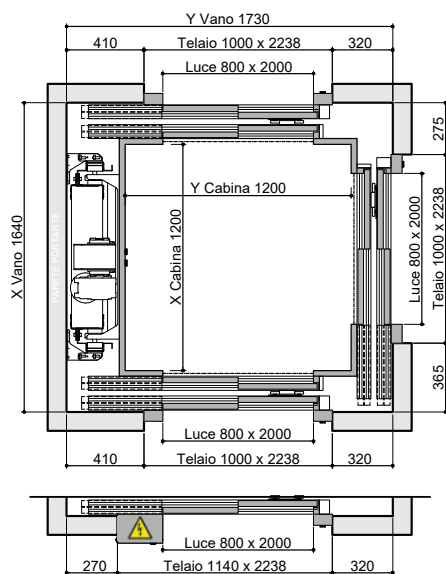

Armadio a muro

2A

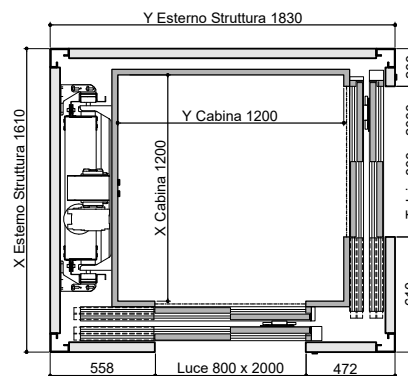
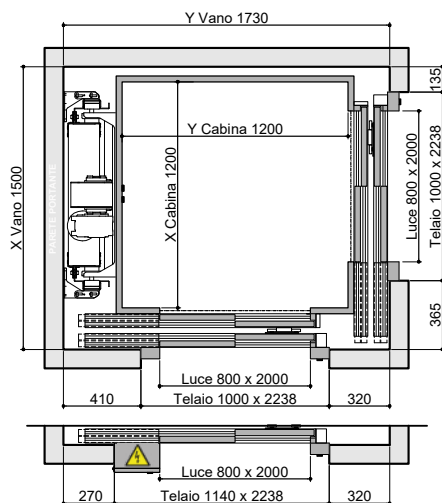

Armadio a muro

<sup>1</sup>Gli ingombri potrebbero subire variazioni in funzione delle condizioni di ancoraggio e delle caratteristiche della fornitura (passerelle, parapetti, ecc..). Nel caso siano previste diagonali, considerare un ingombro di 20/30 mm in più sul lato dove saranno installate.



950 X 1300 portata 350 Kg

1100 X 1400 portata 400 Kg



Accessi Vano in muratura

Vano in struttura<sup>1</sup>

Vano in muratura

Vano in struttura<sup>1</sup>

1L

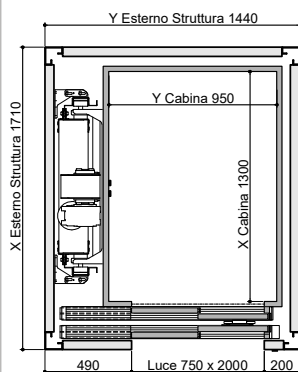
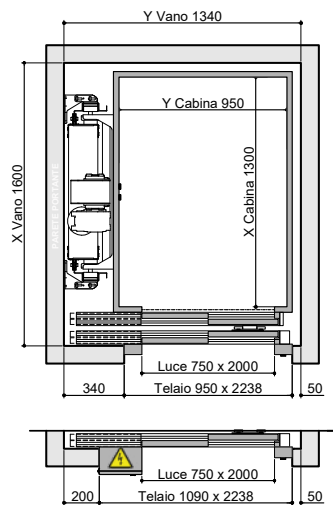

Armadio a muro

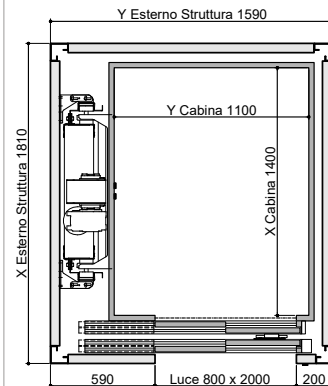
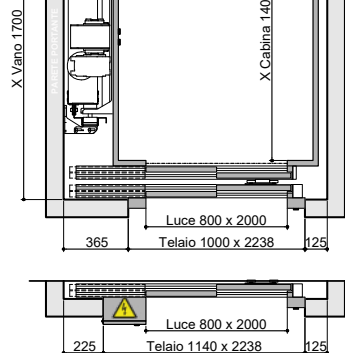

Armadio a muro

1F

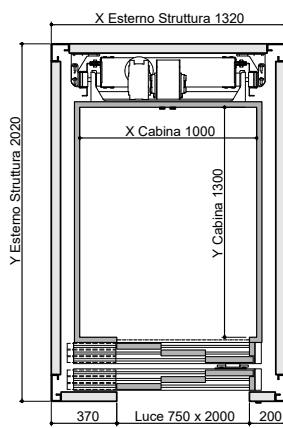
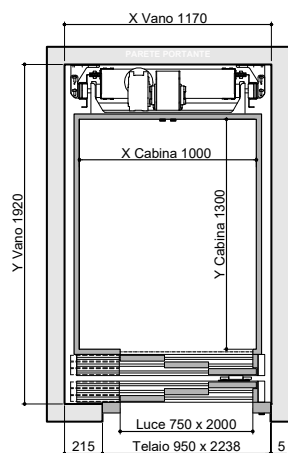

Armadio a muro

Armadio a muro

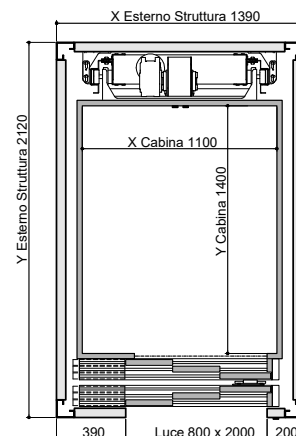
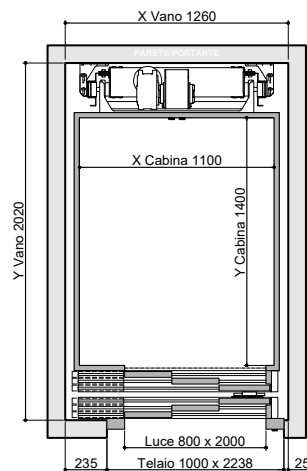

Armadio a muro

Armadio a muro

20

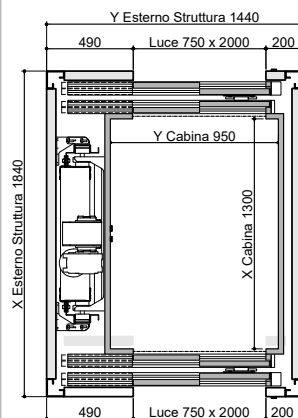
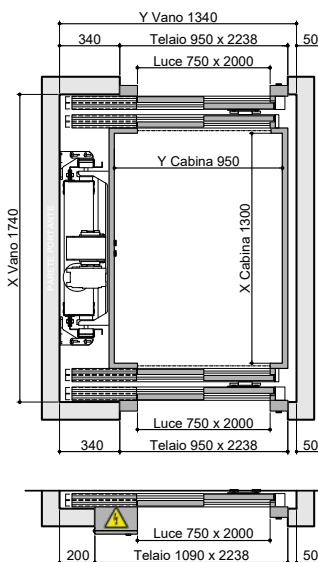

Armadio a muro

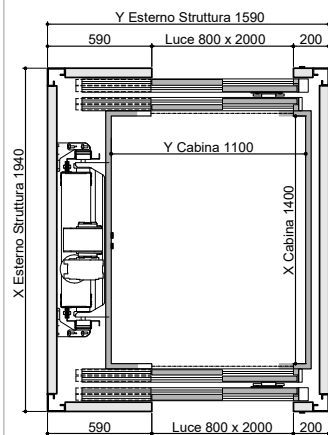
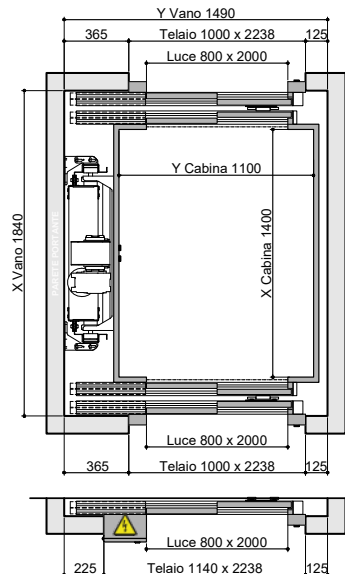

Armadio a muro

<sup>1</sup>Gli ingombri potrebbero subire variazioni in funzione delle condizioni di ancoraggio e delle caratteristiche della fornitura (passerelle, parapetti, ecc.). Nel caso siano previste diagonali, considerare un ingombro di 20/30 mm in più sul lato dove saranno installate.



1300 X 1300 portata 450 Kg

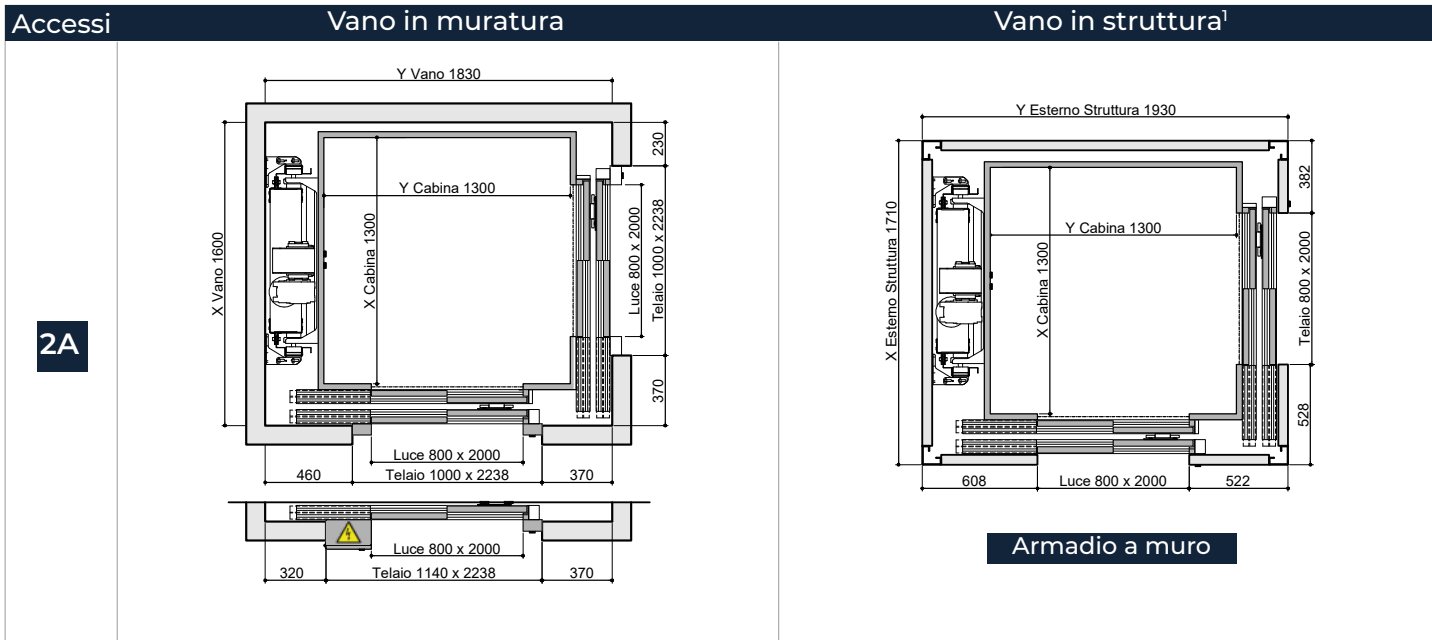

1400 X 1400 portata 500 Kg

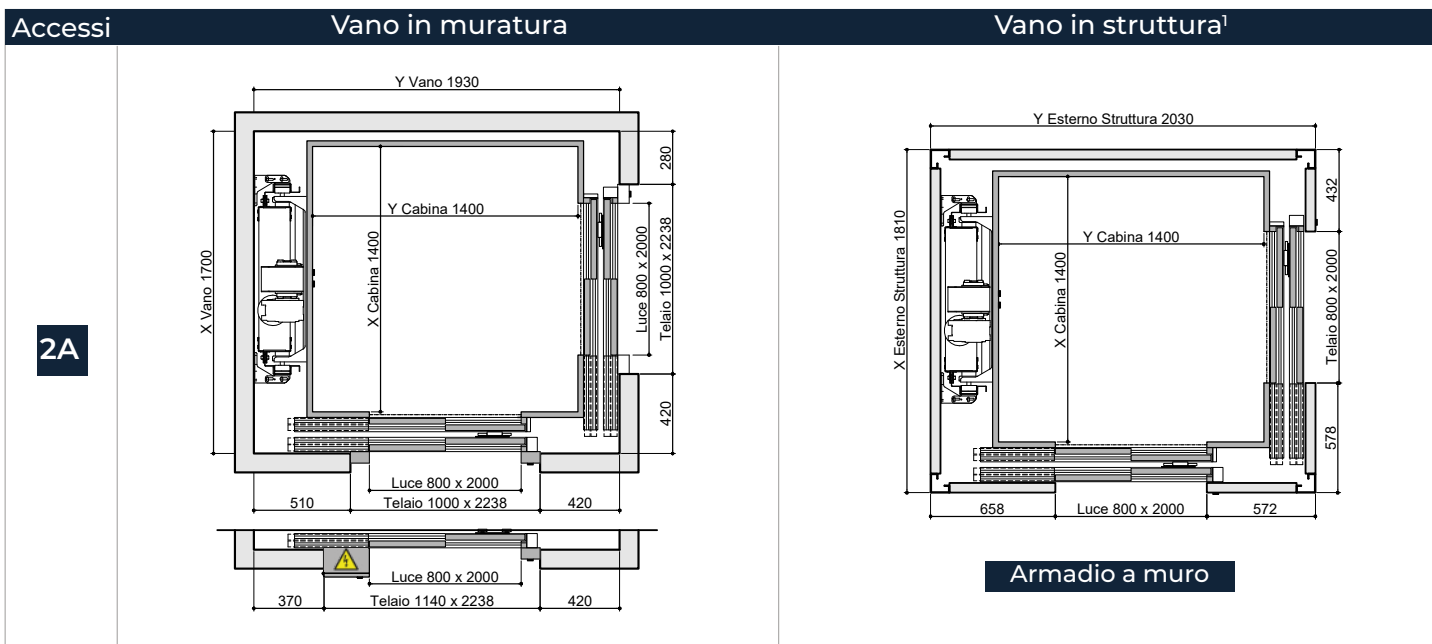

<sup>1</sup>Gli ingombri potrebbero subire variazioni in funzione delle condizioni di ancoraggio e delle caratteristiche della fornitura (passerelle, parapetti, ecc..). Nel caso siano previste diagonali, considerare un ingombro di 20/30 mm in più sul lato dove saranno installate.



1000 X 2000 portata 500 Kg

Accessi

Vano in muratura

Vano in struttura<sup>1</sup>

1L

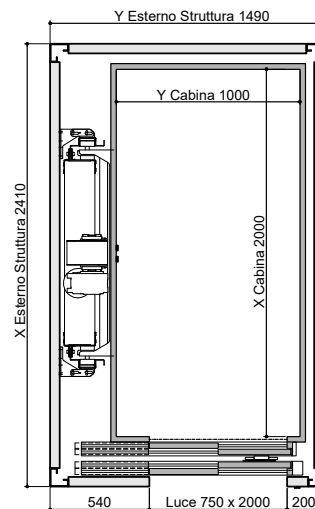
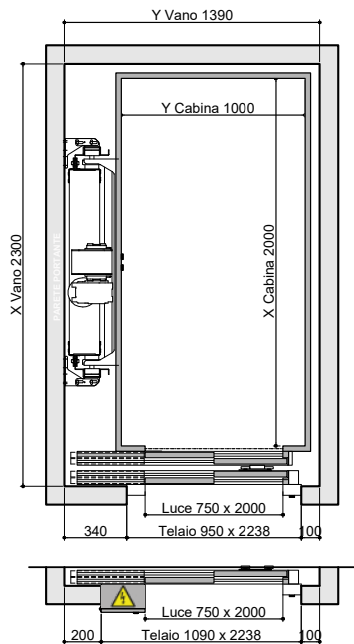

Armadio a muro

2A

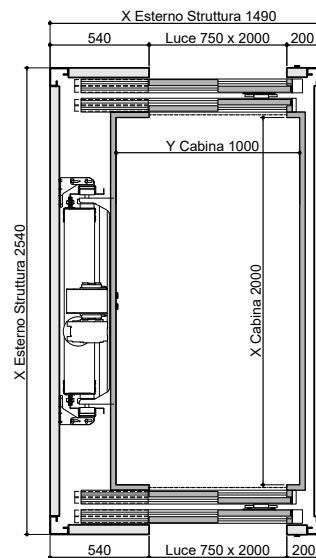
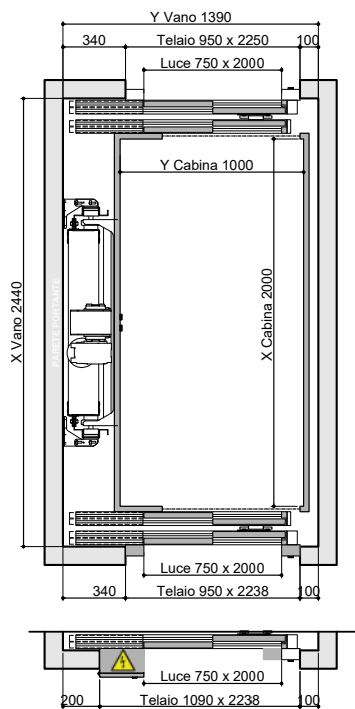

Armadio a muro

<sup>1</sup>Gli ingombri potrebbero subire variazioni in funzione delle condizioni di ancoraggio e delle caratteristiche della fornitura (passerelle, parapetti, ecc..). Nel caso siano previste diagonali, considerare un ingombro di 20/30 mm in più sul lato dove saranno installate.

SENZA PORTE IN CABINA

CON SOFFIETTO

Accessi	Vano in muratura	Vano in struttura <sup>1</sup>
<b>1L</b>		
<b>1F</b>		
<b>20</b>		
<b>2A</b>		

Vano in muratura	Vano in struttura <sup>1</sup>

<sup>1</sup>Gli ingombri potrebbero subire variazioni in funzione delle condizioni di ancoraggio e delle caratteristiche della fornitura (passerelle, parapetti, ecc.). Nel caso siano previste diagonali, considerare un ingombro di 20/30 mm in più sul lato dove saranno installate.



## CON PORTE AUTOMATICHE

Accessi

Vano in muratura

Vano in struttura<sup>1</sup>

1L

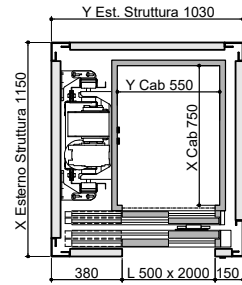
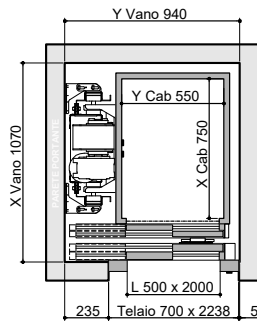

1F

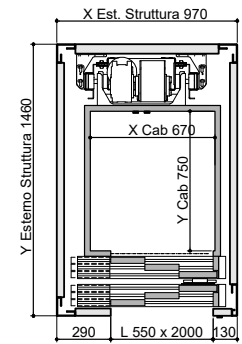
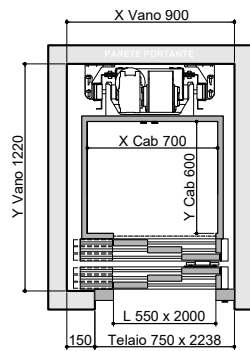

20

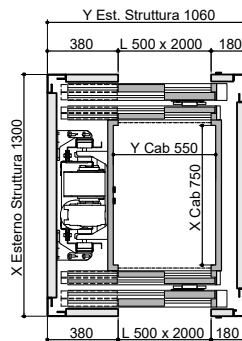
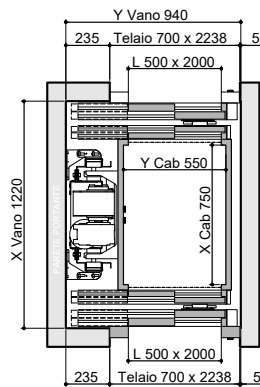

2A

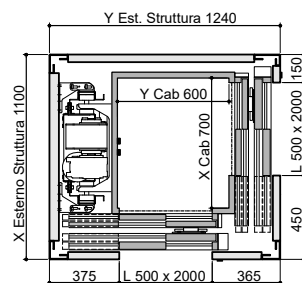
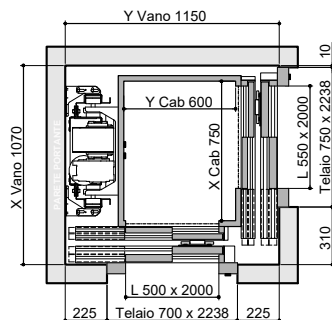

<sup>1</sup>Gli ingombri potrebbero subire variazioni in funzione delle condizioni di ancoraggio e delle caratteristiche della fornitura (passerelle, parapetti, ecc..). Nel caso siano previste diagonali, considerare un ingombro di 20/30 mm in più sul lato dove saranno installate.

# I PIÙ PICCOLI 3 ACCESSI

	Vano in muratura	Vano in struttura <sup>1</sup>
SENZA PORTE	<p>Y Vano 930 220 Telaio 700 x 2100 10 L 500 x 2000 Y Cab 550 X Cab 600 X Vano 740 L 500 x 2000 Telaio 700 x 2100 20 20 L 500 x 2000 Telaio 700 x 2100 10</p>	<p>Y Esterno Struttura 1170 270 Telaio 750 x 2100 150 L 550 x 2000 Y Cab 700 X Cab 600 X Esterno Struttura 820 L 550 x 2000 Telaio 750 x 2100 35 35 L 550 x 2000 Telaio 750 x 2100 150</p>
CON SOFFIETTO	<p>Y Vano 1020 235 Telaio 700 x 2100 85 L 500 x 2000 Y Cab 650 X Cab 850 X Vano 970 L 500 x 2000 Telaio 700 x 2100 135 135 L 500 x 2000 Telaio 700 x 2100 85</p>	<p>Y Esterno Struttura 1160 285 Telaio 700 x 2100 75 100 L 500 x 2000 Y Cab 650 X Cab 850 X Esterno Struttura 1050 L 500 x 2000 Telaio 700 x 2100 175 175 L 500 x 2000 Telaio 700 x 2100 100</p>
PORTE TELESCOPICHE	<p>Y Vano 1145 240 Telaio 700 x 2238 205 L 500 x 2000 Y Cab 600 X Cab 750 X Vano 1220 L 550 x 2000 Telaio 750 x 2238 160 310 L 500 x 2000 Telaio 700 x 2238 205</p>	<p>Y Est. Struttura 1235 390 L 500 x 2000 345 Y Cab 600 X Cab 750 X Esterno Struttura 1300 L 550 x 2000 Telaio 750 x 2100 315 435 L 500 x 2000 Telaio 750 x 2100 345</p>

<sup>1</sup>Gli ingombri potrebbero subire variazioni in funzione delle condizioni di ancoraggio e delle caratteristiche della fornitura (passerelle, parapetti, ecc..). Nel caso siano previste diagonali, considerare un ingombro di 20/30 mm in più sul lato dove saranno installate.

# SPECIALI

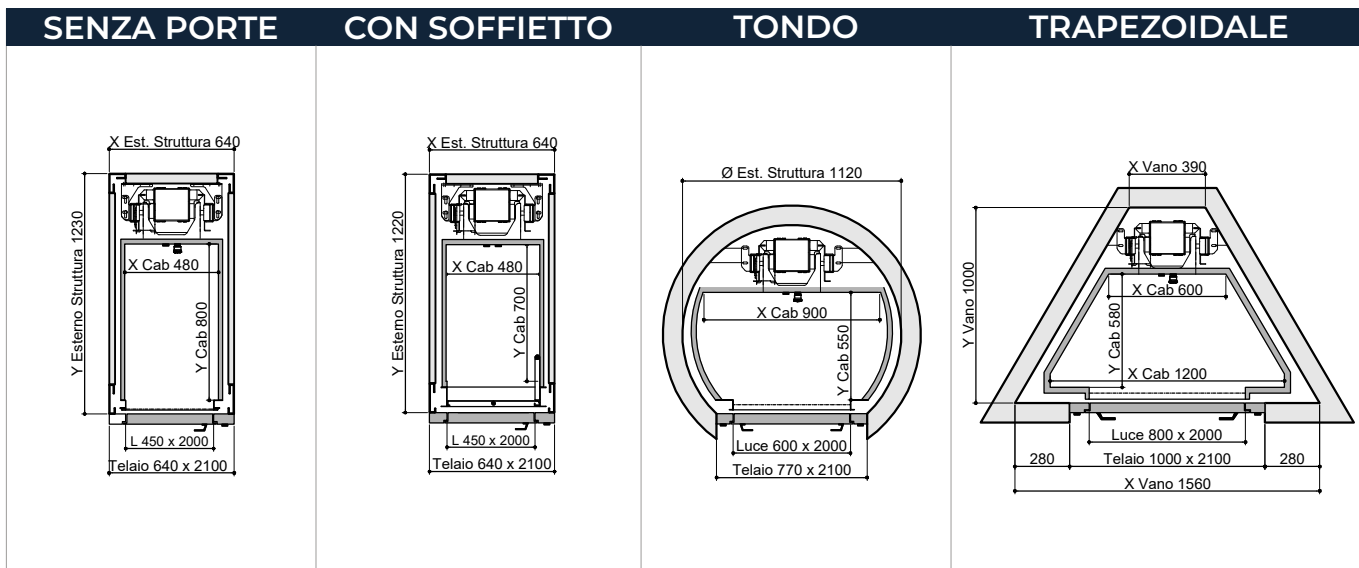

Testata minima 2600mm

## ARMADIO TECNICO

### Fianco porta a battente

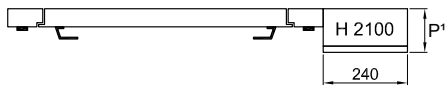

FINITURE:  
✓ Come porta di piano

### A muro H2100

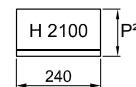

FINITURE:  
✓ Come porta di piano  
✓ Con vano in struttura verniciato RAL come la struttura

### Fianco porta automatica<sup>1</sup>

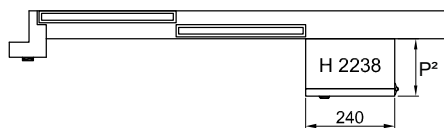

FINITURE:  
✓ Come porta di piano

### A muro H800

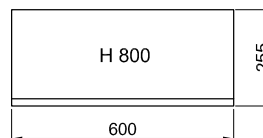

FINITURE:  
✓ Verniciatura RAL 7035

P<sup>1</sup> = 145 con portata ≤ 400 kg; 170 con portata > 400 kg

P<sup>2</sup> = 150 con portata ≤ 400 kg; 175 con portata > 400 kg

<sup>1</sup> Non è possibile con porte Glass & Metal, Total Glass, 3AT, con altezza porte fuori standard ed EI